

High Flux Neutron Diffractometers

Alan Hewat, ILL Grenoble

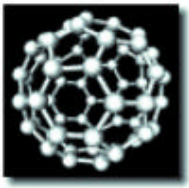

BCA Loughborough 12 April 2005



High Flux Neutron Diffractometers

Alan Hewat, ILL Grenoble

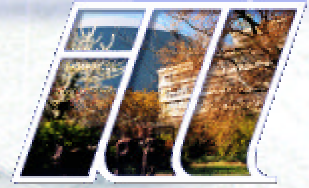

Classical Neutron Diffraction from a single crystal

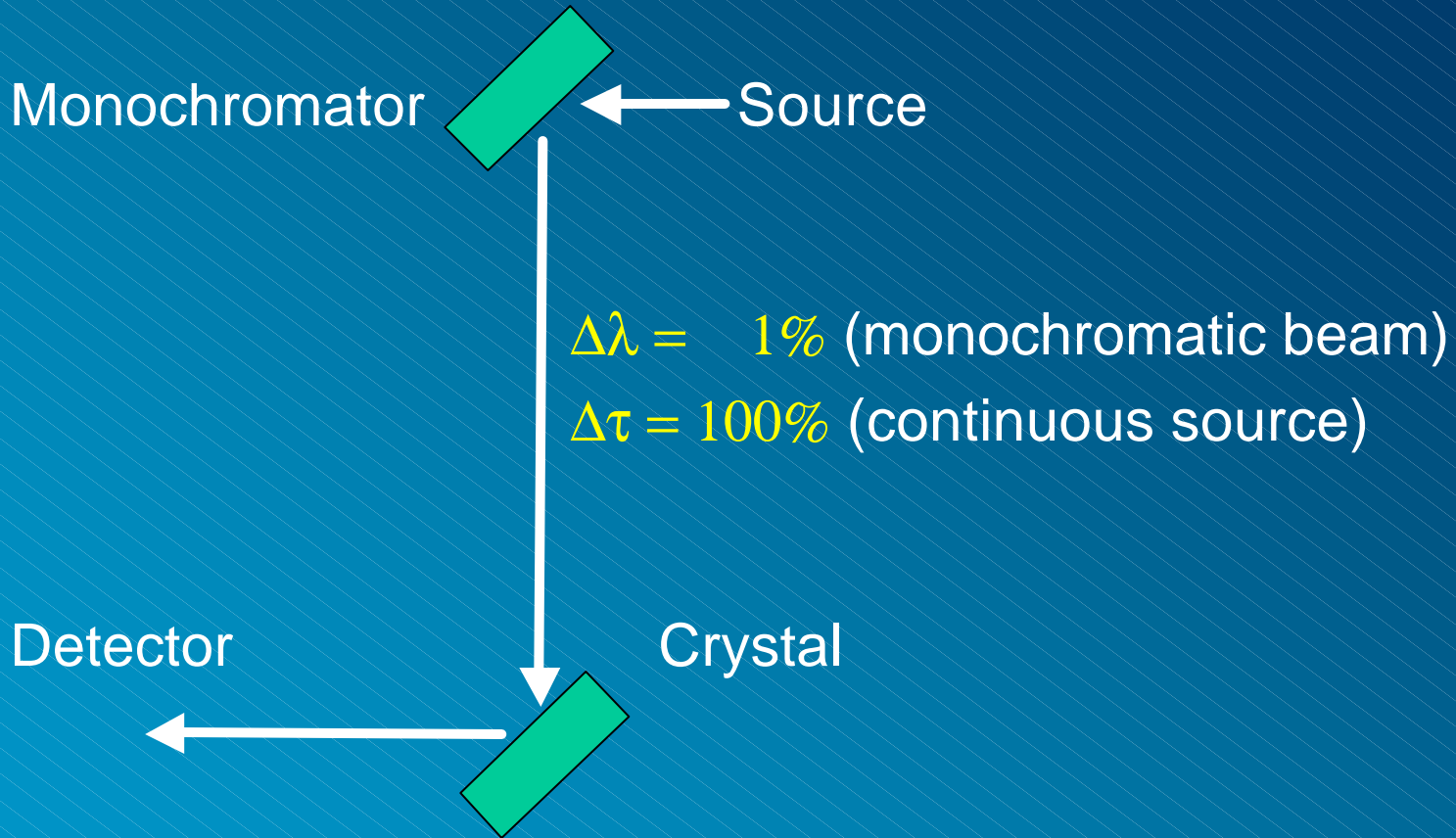

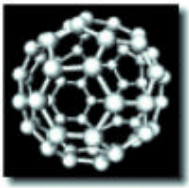

High Flux Neutron Diffractometers

Alan Hewat, ILL Grenoble

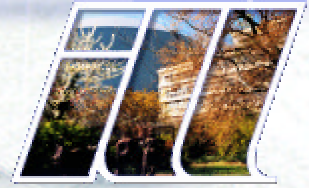

TOF Neutron Diffraction from a single crystal
Multiple reflections sorted by Time-Of-Flight

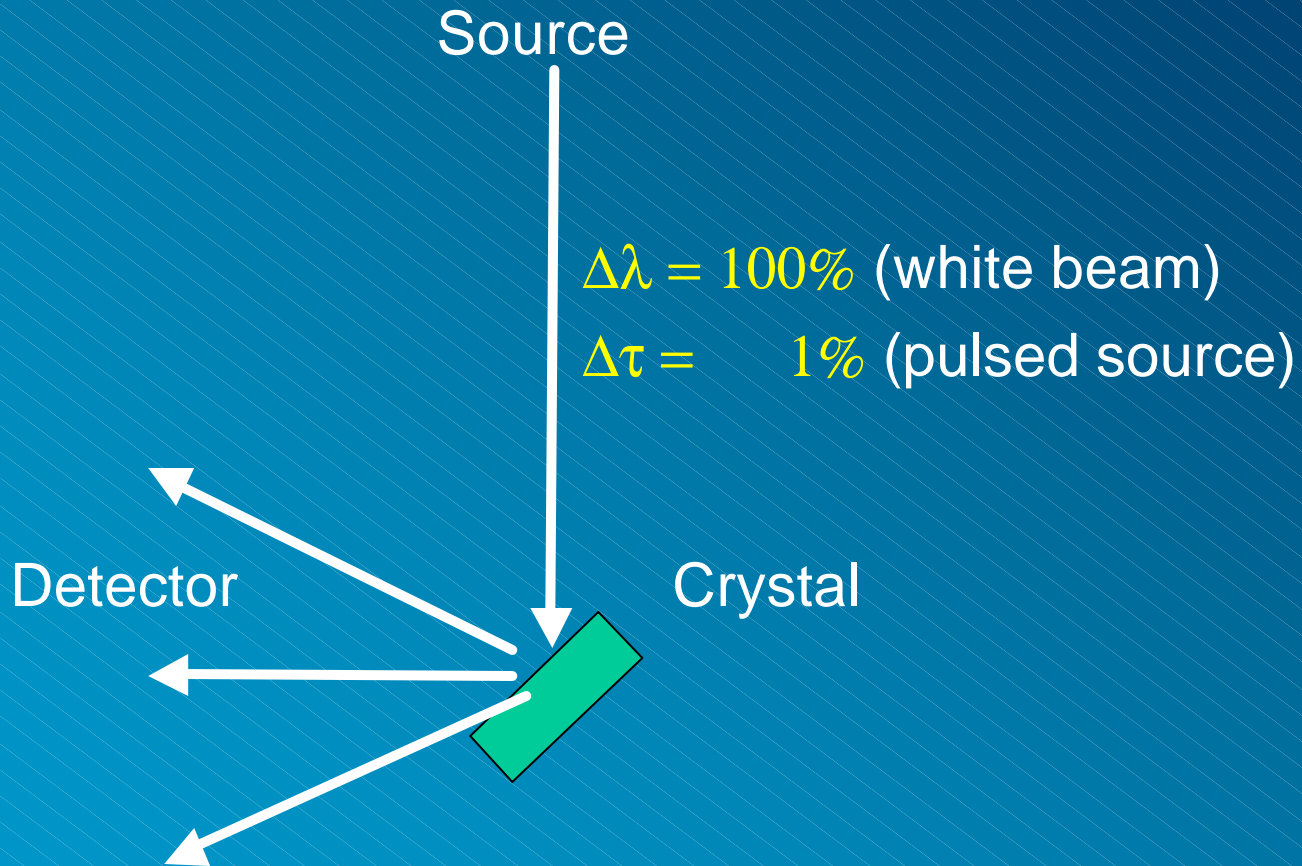

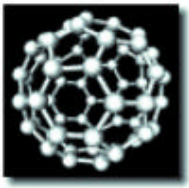

High Flux Neutron Diffractometers

Alan Hewat, ILL Grenoble

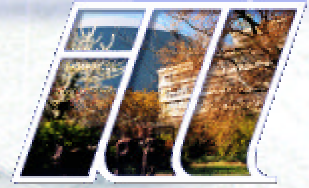

White Beam Neutron Diffraction from a single crystal
Multiple reflections **sorted by the Crystal itself**

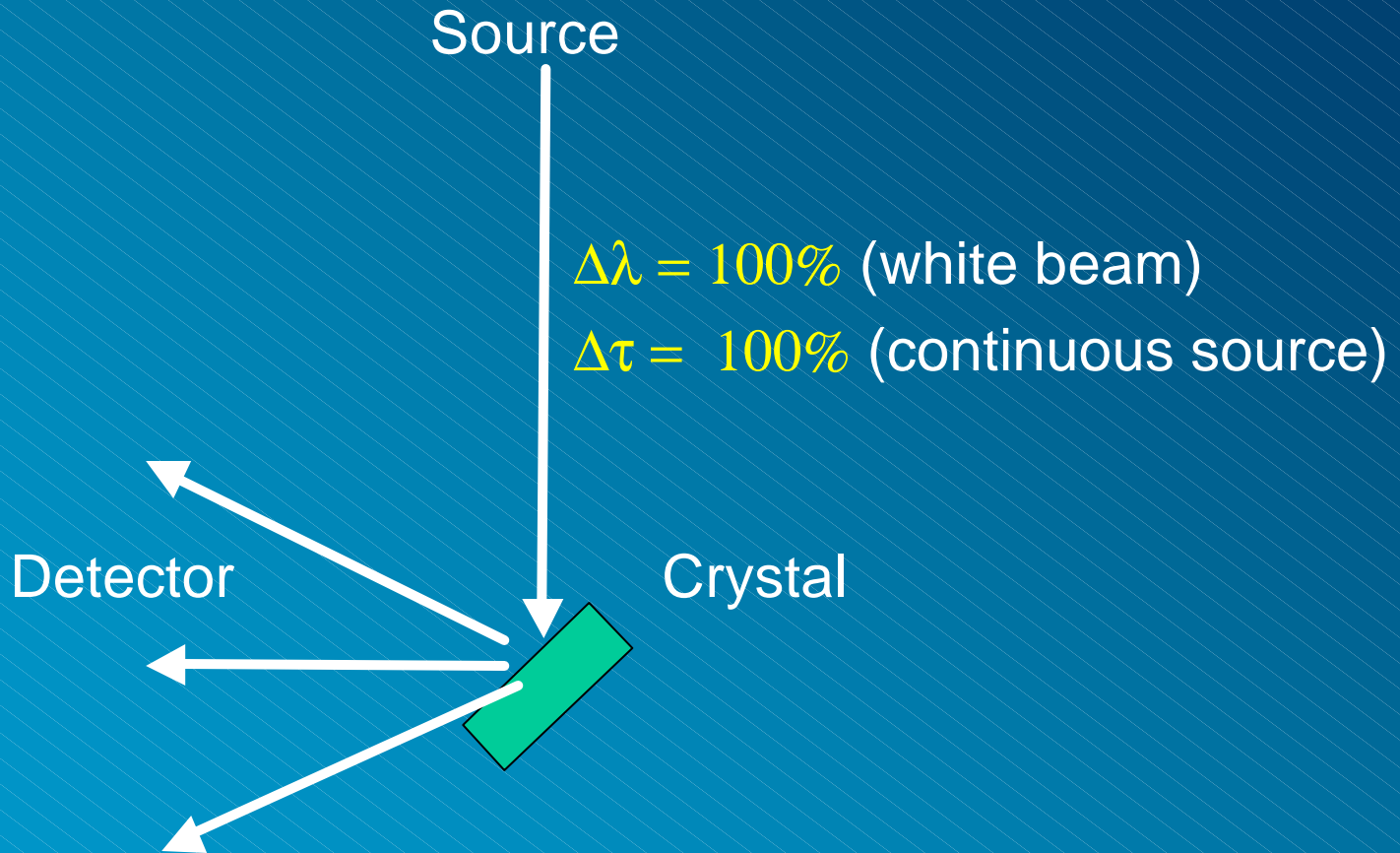

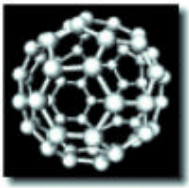

High Flux Neutron Diffractometers

Alan Hewat, ILL Grenoble

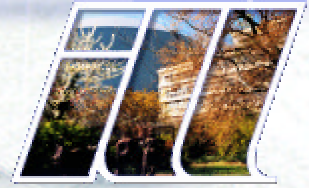

White Beam Neutron Diffraction from a single crystal
Multiple reflections **sorted by the Crystal itself**

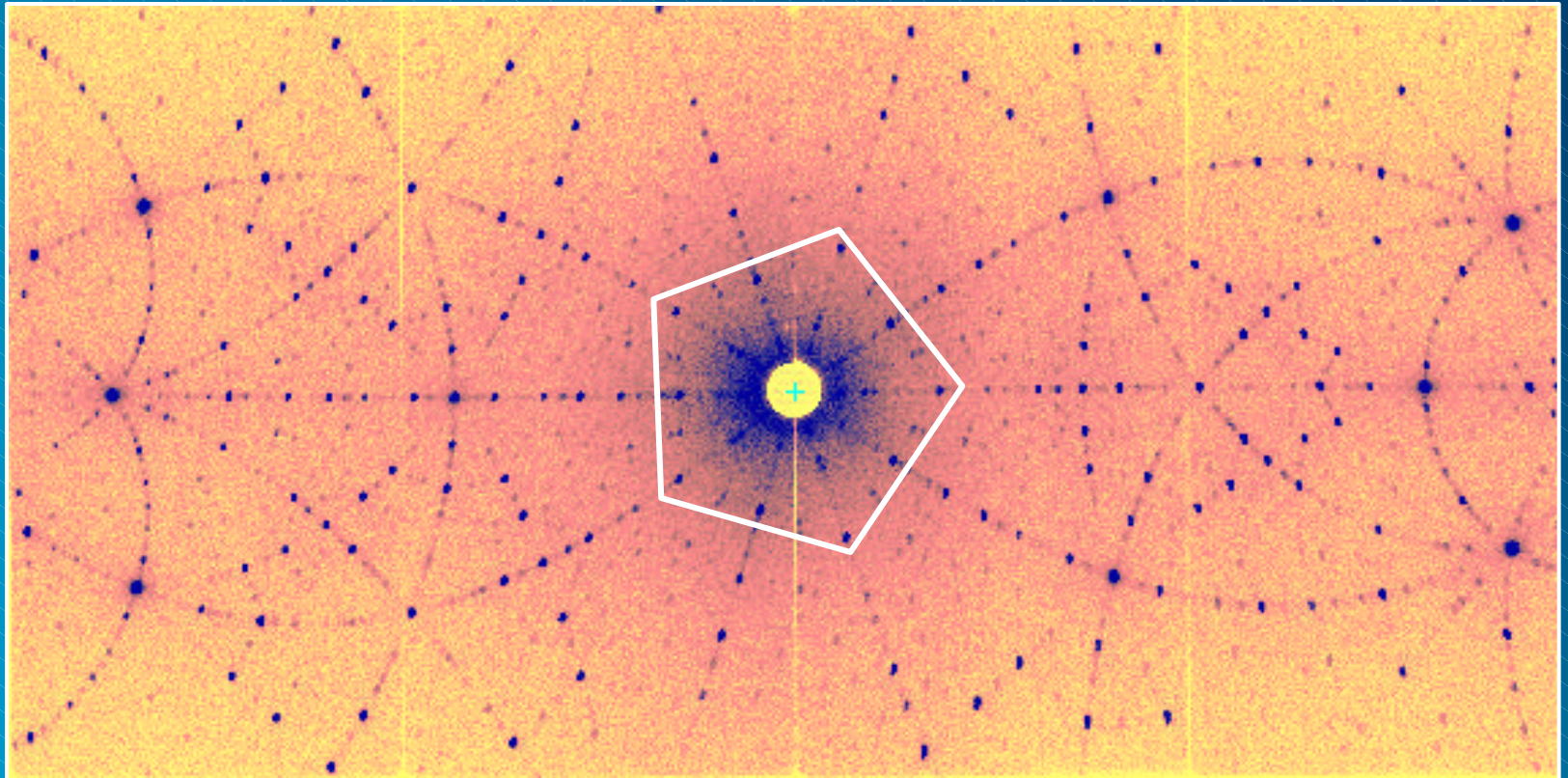

VIVALDI neutron image plate photo courtesy of G. McIntyre, Oct 1999

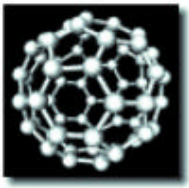

High Flux Neutron Diffractometers

Alan Hewat, ILL Grenoble

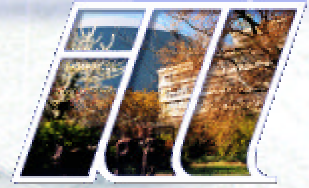

Recipe for a High Flux Neutron Diffractometer

- A continuous neutron source
- A wide band of wavelengths
- A very high flux on the sample
- A very large area detector

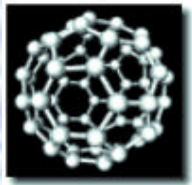

ORIENT EXPRESS, a new diffractometer

Bachir Ouladdiaf, ILL Grenoble



Orient Express

On H24 thermal neutron guide

Orient Express team

- Bachir Ouladdiaf (scientist)
- John Archer (D9/D19 technician)
- Eric Bougeot-Lami (D3 technician)
- Ph. Decarpentrie (D10 technician)

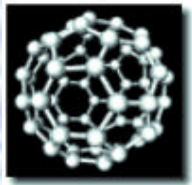

ORIENT EXPRESS, a new diffractometer

Bachir Ouladdiaf, ILL Grenoble



Orient Express & Bachir Ouladdiaf On H24 thermal neutron guide

Orient Express team

- Bachir Ouladdiaf (D10 scientist)
- John Archer (D9/D19 technician)
- Eric Bougeot-Lami (D3 technician)
- Ph. Decarpentrie (D10 technician)

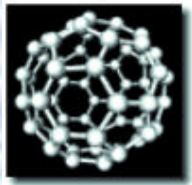

ORIENT EXPRESS, a new diffractometer

Bachir Ouladdiaf, ILL Grenoble

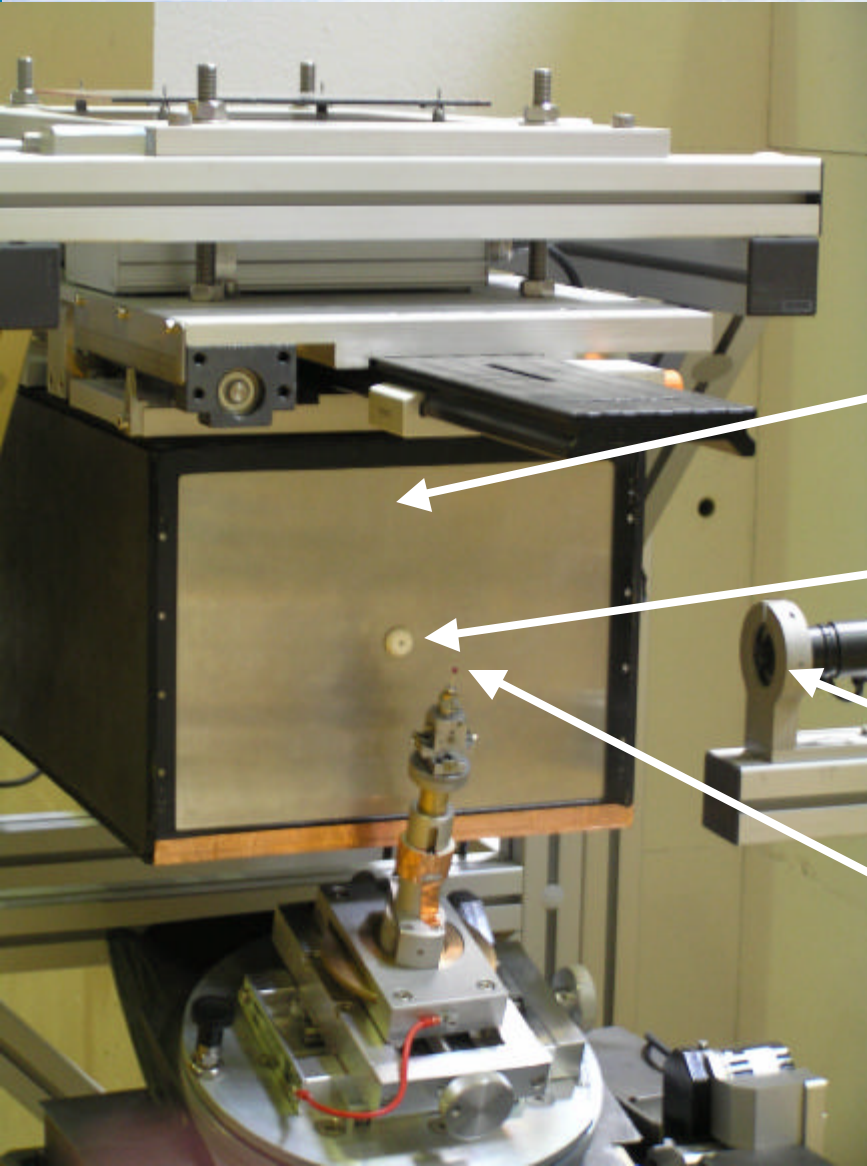

Orient Express

On H24 thermal neutron guide

CCD detector in backscattering

Neutron beam

TV camera for crystal alignment

Crystal on goniometer

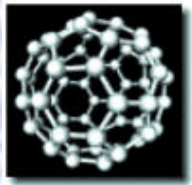

ORIENT EXPRESS, a new diffractometer

Bachir Ouladdiaf, ILL Grenoble



Orient Express & John Archer

- Simple **uncooled** CCD detectors
- A pair of TV cameras + computer
- Backscattering for high resolution
- Hot-cold air blower possible
- "Arndt Camera" proposed
30 years ago (cf Arndt & Willis)

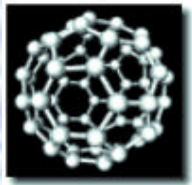

ORIENT EXPRESS, a new diffractometer

Bachir Ouladdiaf, ILL Grenoble

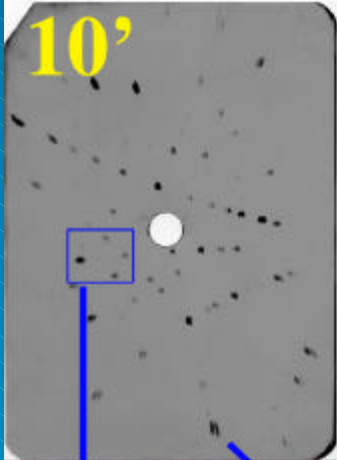
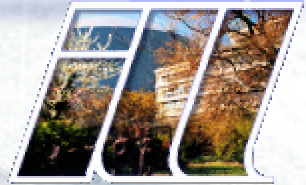

10'' Ruby test crystal

10 minutes with photographic film

10 seconds with neutron CCD camera

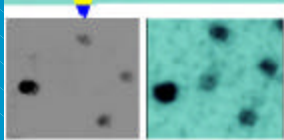
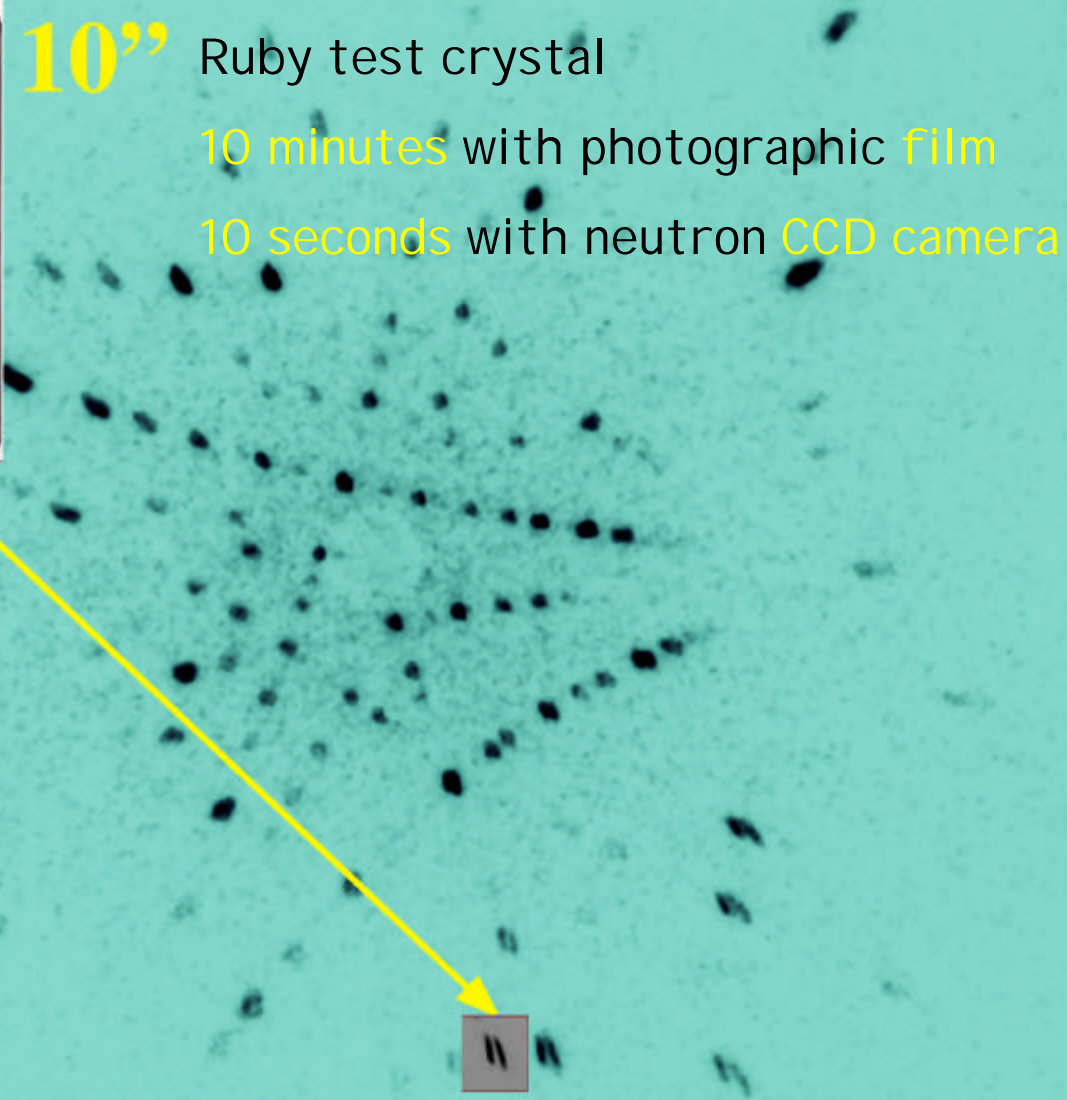

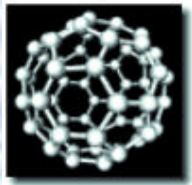

ORIENT EXPRESS, a new diffractometer

Bachir Ouladdiaf, ILL Grenoble



GdCuO₄ (strong neutron absorber)
80 minutes with photographic film

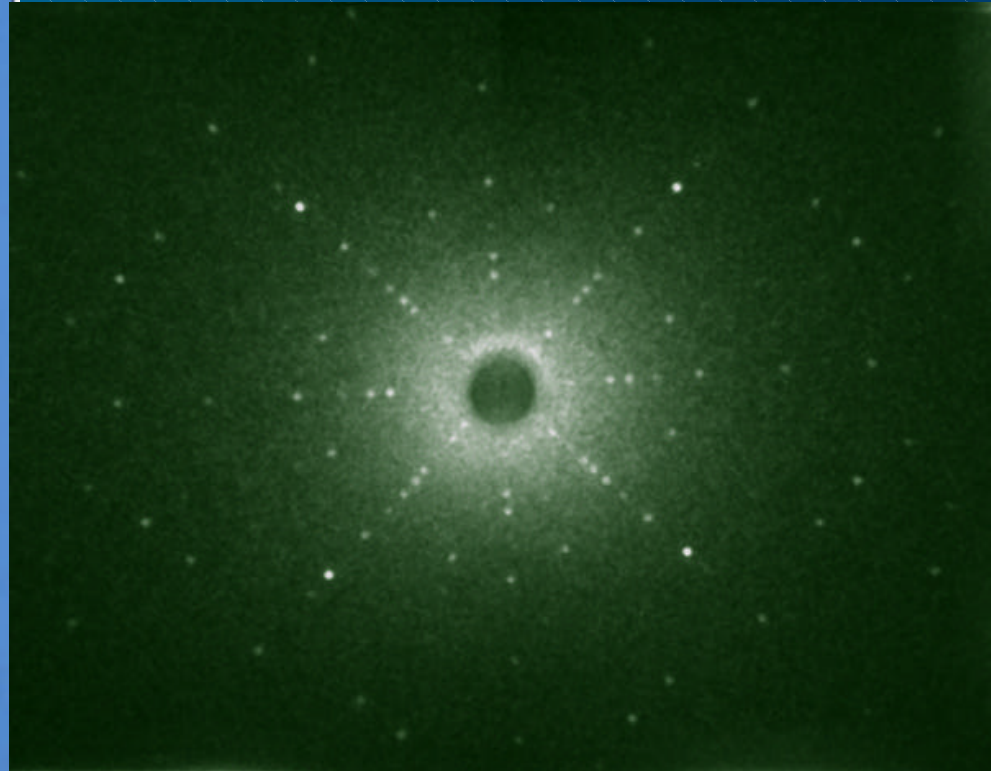

90 seconds with neutron CCD camera

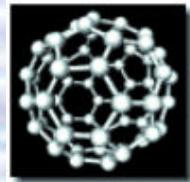

HoMnO₃ - 90 secs on ORIENT EXPRESS

Bachir Ouladdiaf, ILL Grenoble

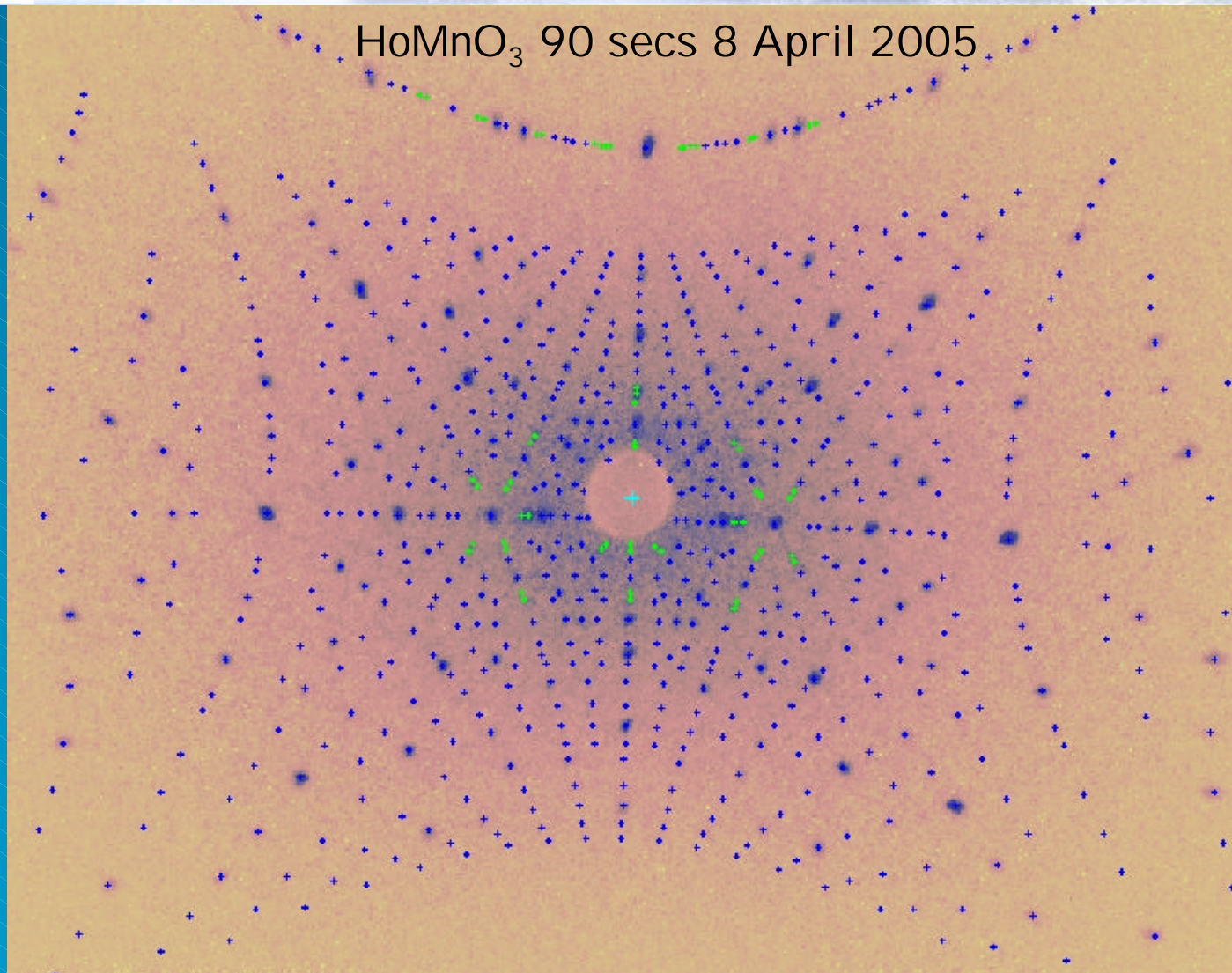

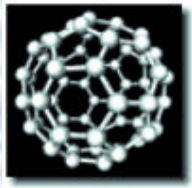

ORIENT EXPRESS, a new diffractometer

Bachir Ouladdiaf, ILL Grenoble

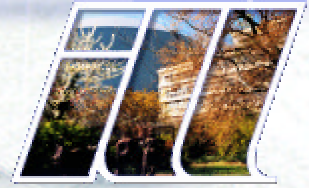

How do neutron CCD detectors compare ?

- x3 more efficient than neutron Image Plates (VIVALDI)
- Otherwise similar advantages & disadvantages
- Need cooled CCDs for low BG (we use cheap video types)
- ORIENT EXPRESS is fast and user friendly

VIVALDI, Neutron Image Plate machine

Garry McIntyre, Clive Wilkinson, ILL Grenoble

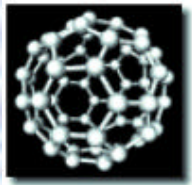

New thermal VIVALDI (2002)
On H22 super-mirror guide

"As Powerful as Powders"
G. McIntyre

VIVALDI, Neutron Image Plate machine

Garry McIntyre, Clive Wilkinson, ILL Grenoble

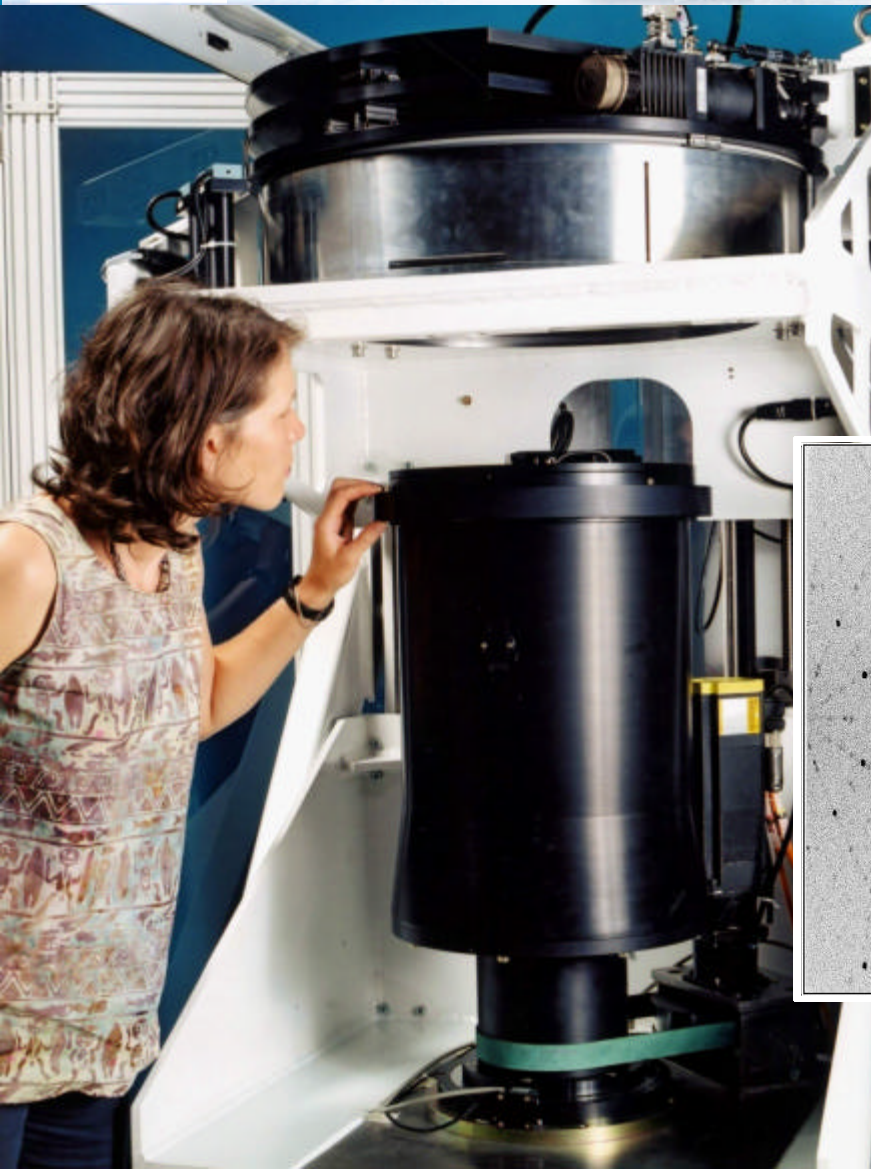
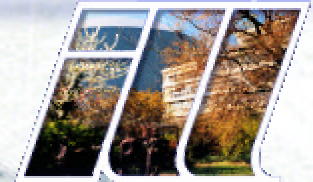
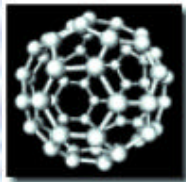

New thermal VIVALDI (2002)
On H22 super-mirror guide

"As Powerful as Powders"
G. McIntyre

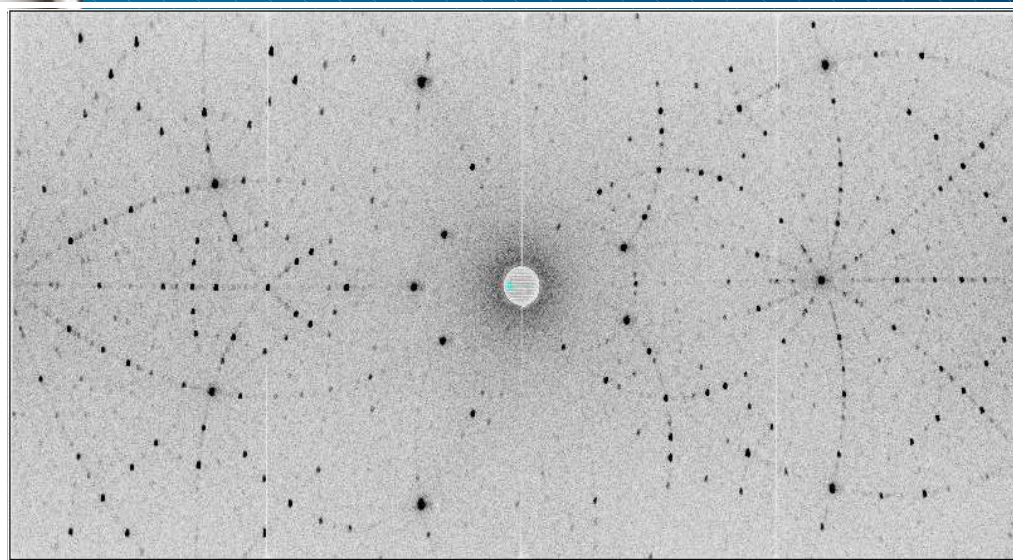

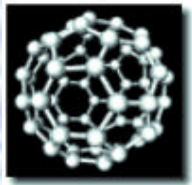

VIVALDI, Neutron Image Plate machine

Garry McIntyre, Clive Wilkinson, ILL Grenoble

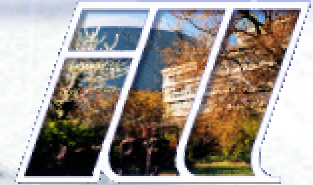

First experiments on VIVALDI

Very fast data collection over all of reciprocal space for very small samples

Compound	Volume (mm ³)	Unitcell (Å ³)	Expose (hr)	No. Peaks	I/s(I)	Total (hr)
Vitamin B12	6	8853	2	7596	10.1	60
Cs ₃ VCl ₆ .4H ₂ O	2	446	0.7	647	6.6	3
Na ₂ Pb(OH) ₂	2	147	0.8	263	7.9	5
LiAlSi ₂ O ₆	1.4	389	0.33	442	11.9	2
Co(NH ₃) ₆ .CuCl ₅	1	2691	0.7	1865	6.0	3
C ₀₄ C ₂₂ H ₃₆	0.6	8254	2.5	4340	4.8	22
dabcoHBF ₄	0.21	473	1	384	5.0	10
Cd ₂ Nb ₂ O ₇	0.07	279	2	204	3.1	*
C ₄ H ₄ N ₂ O ₂	0.00075	451	4	272	1.1	48
(NH ₄) ₂ Cr(SO ₄) ₂ .6H ₂ O	3.5**	726	1	557	5.6	4

**10 kbar TiZr pressure cell !!

SALSA, Neutron Strain Scanner

Ph. Withers, G. Bruno (Manchester), Th. Pirling (ILL)



SALSA - It's Hot

On H22 super-mirror thermal guide

The all-singing & dancing Strain Scanner

- High neutron flux
- Samples up to 500 kg weight.
- Stewart Platform (hexapod)
very strong, yet very precise.

SALSA, Neutron Strain Scanner

Ph. Withers, G. Bruno (Manchester), Th. Pirling (ILL)

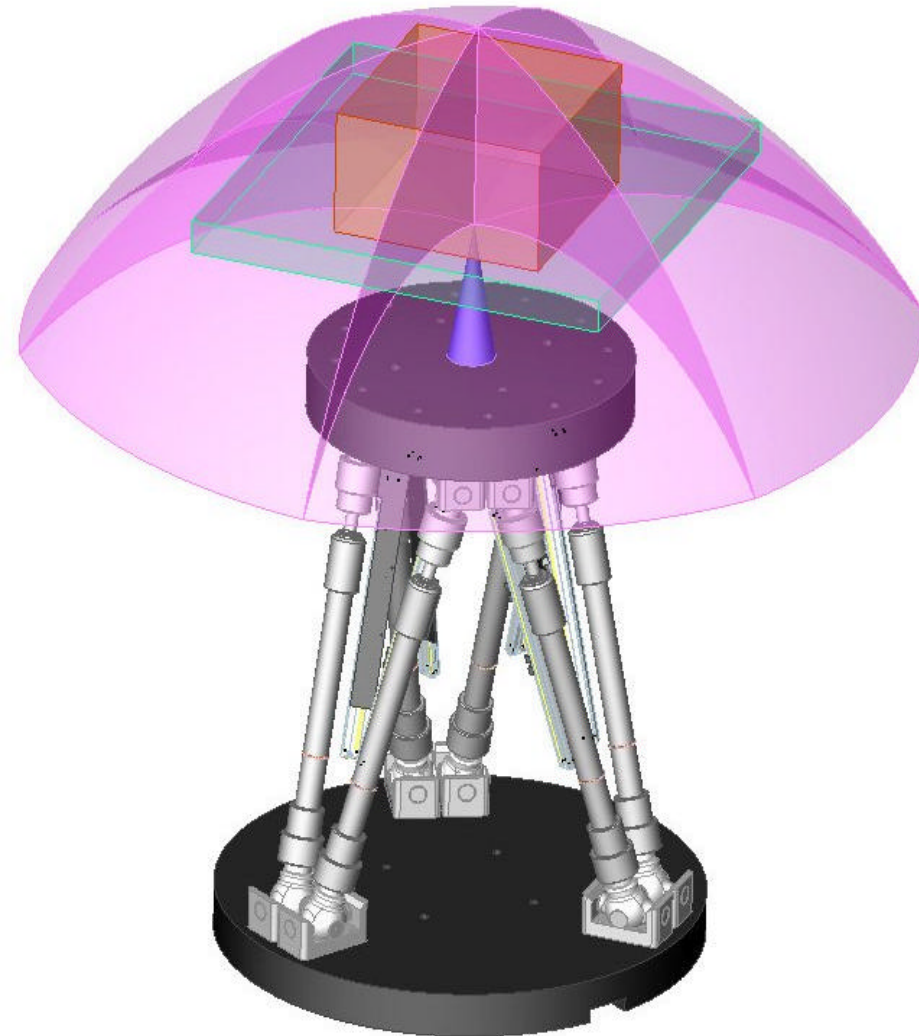
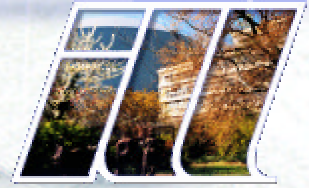

SALSA - It's Hot

On H22 super-mirror thermal guide

- Stewart platform (Hexapod)
- High flexibility
- Laser/Camera system
- Max. load 500 kg
- Air pads

SALSA, Neutron Strain Scanner

Ph. Withers, G. Bruno (Manchester), Th. Pirling (ILL)

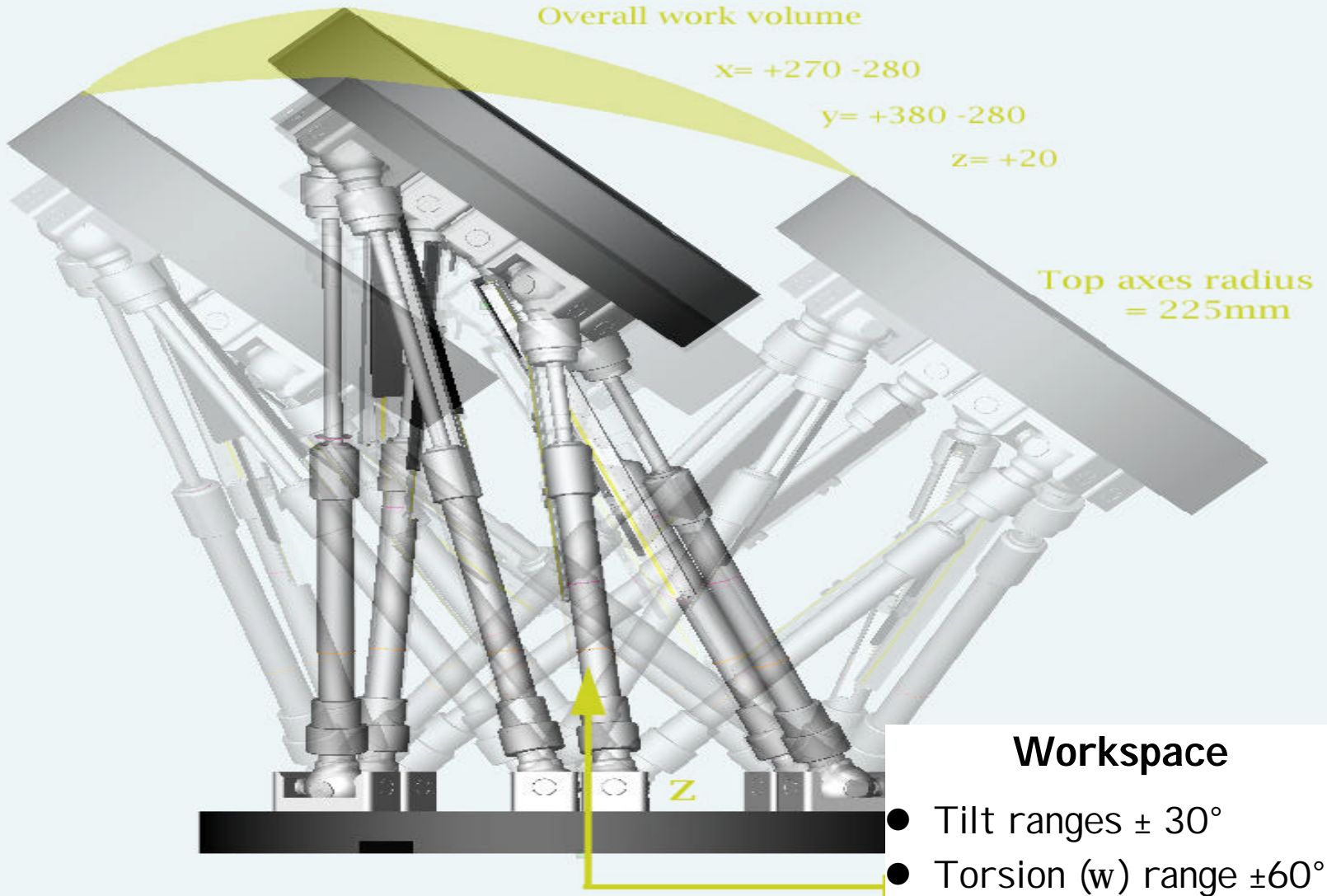

SALSA, Neutron Strain Scanner

Ph. Withers, G. Bruno (Manchester), Th. Pirling (ILL)

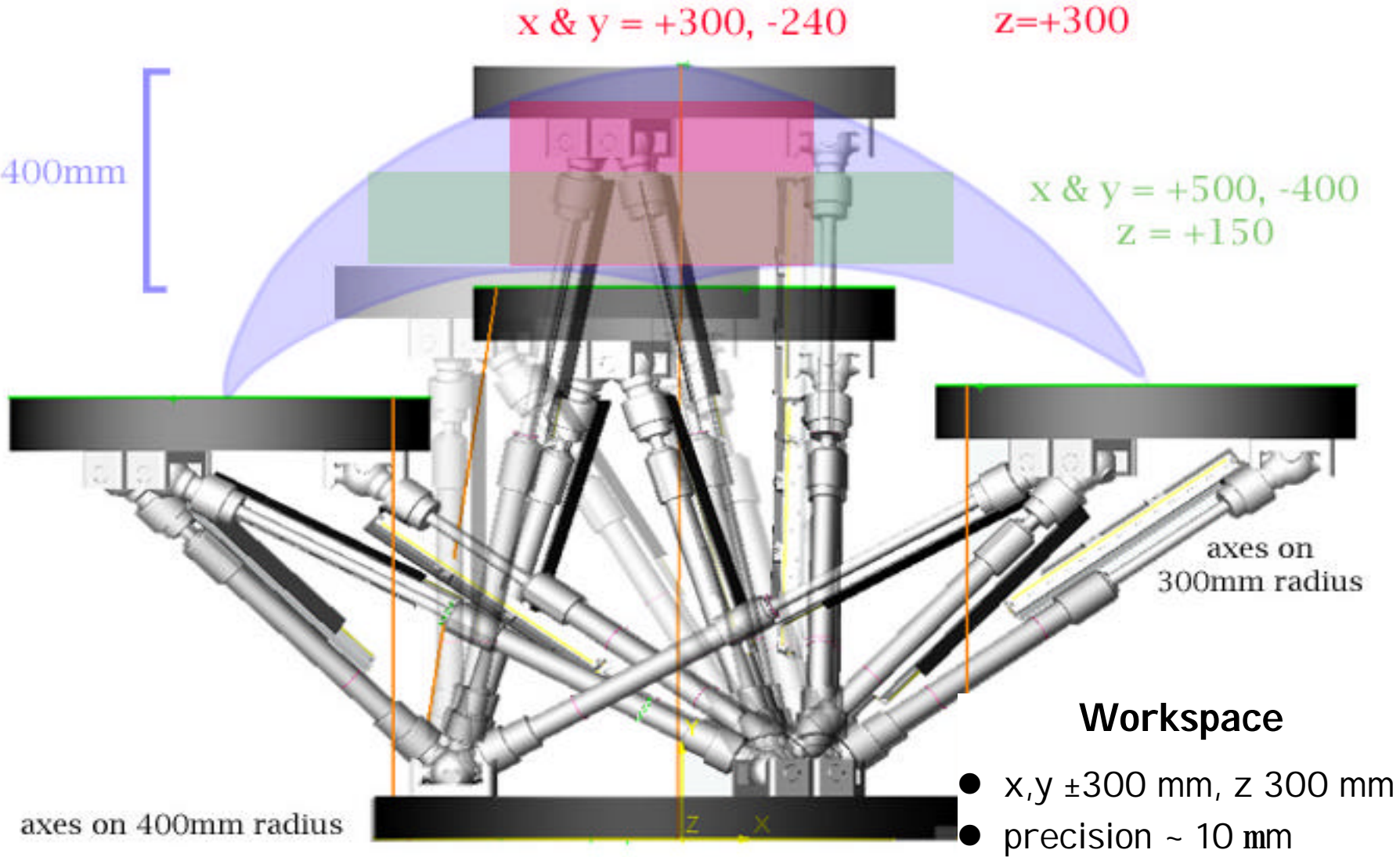

SALSA, Neutron Strain Scanner

Ph. Withers, G. Bruno (Manchester), Th. Pirling (ILL)

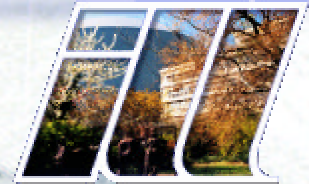

Mark Jacques &
SALSA Hexapod

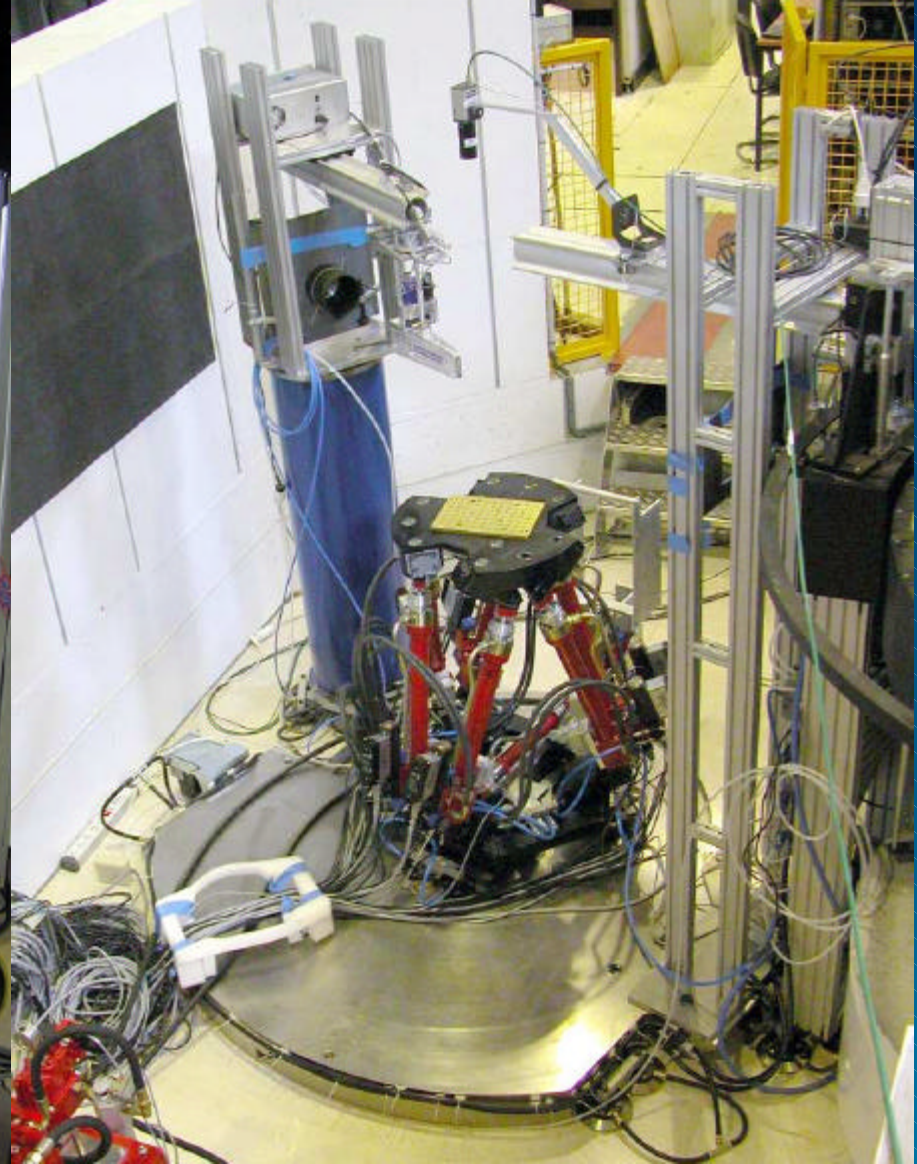

SALSA, Neutron Strain Scanner

Ph. Withers, G. Bruno (Manchester), Th. Pirling (ILL)

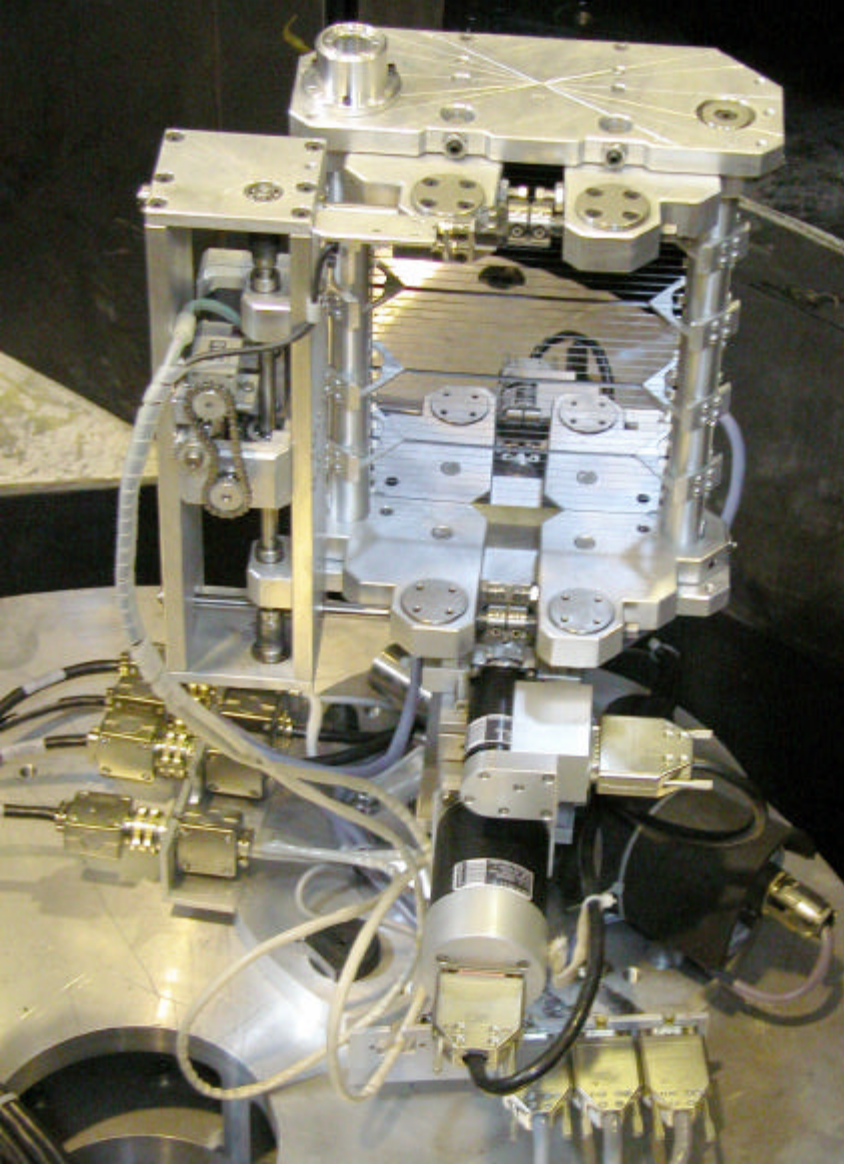

Double-focusing bent perfect Si-monochromator
On H22 super-mirror thermal guide

- Very large Dl/l , high flux on sample

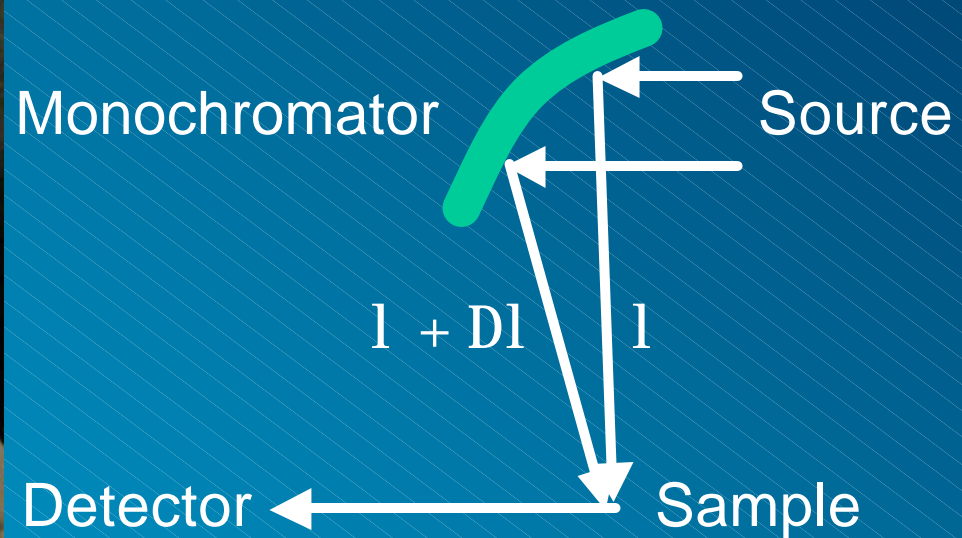

SALSA, Neutron Strain Scanner

Ph. Withers, G. Bruno (Manchester), Th. Pirling (ILL)

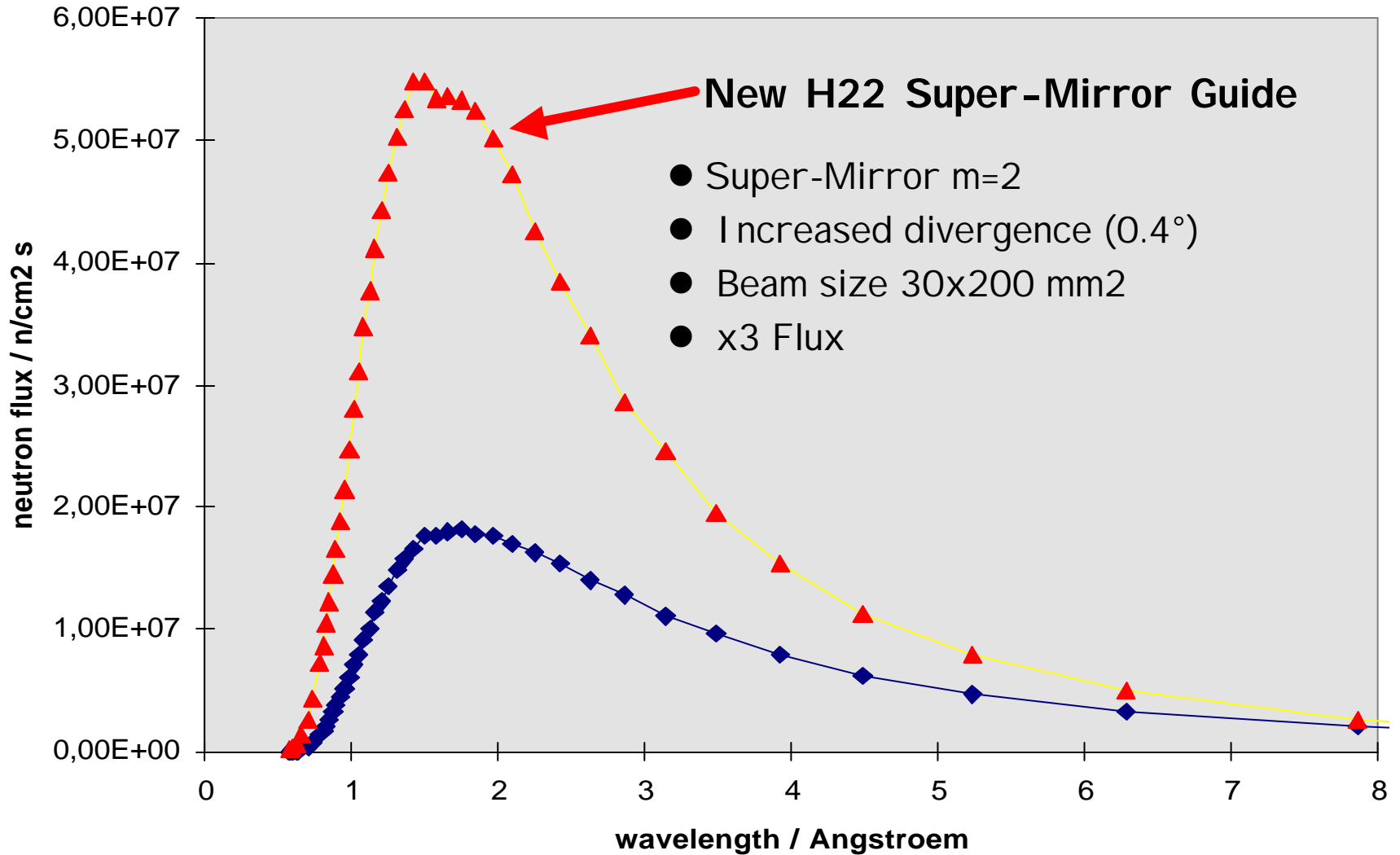

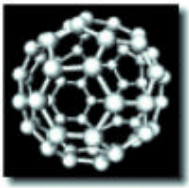

High Flux Neutron Diffractometers

Alan Hewat, ILL Grenoble

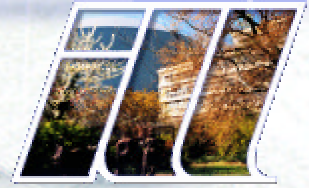

New H22 Super-Mirror Guide for D1A, D1B, SALSA, VIVALDI

- Neutron guide tubes bring the neutrons to the experiment
cf optic fibres
- Super-Mirrors increase the solid angle
cf multiple optical coatings on lenses
- New H22 super-mirror guide (2005)
x4 flux for D1A,D1B,SALSA,VIVALDI
- Already half finished, complete 2005
- However, there is a new proposal to replace all thermal guides by a 3rd ILL cold source.

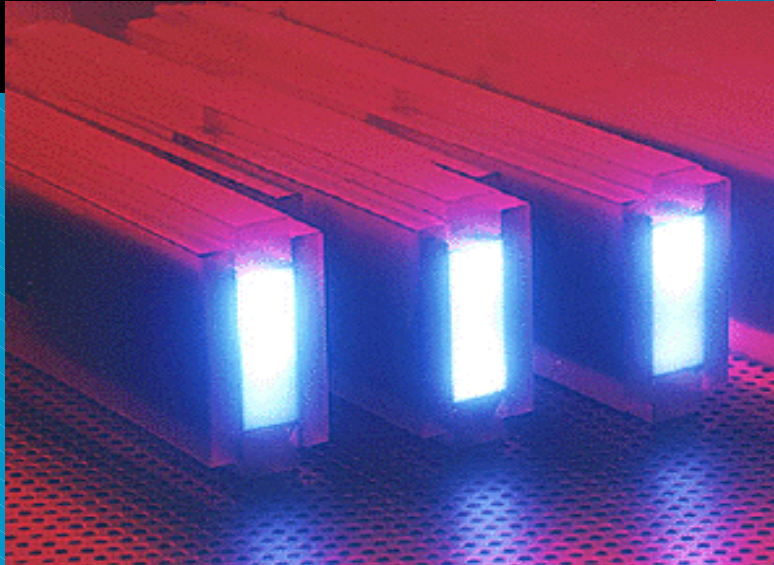
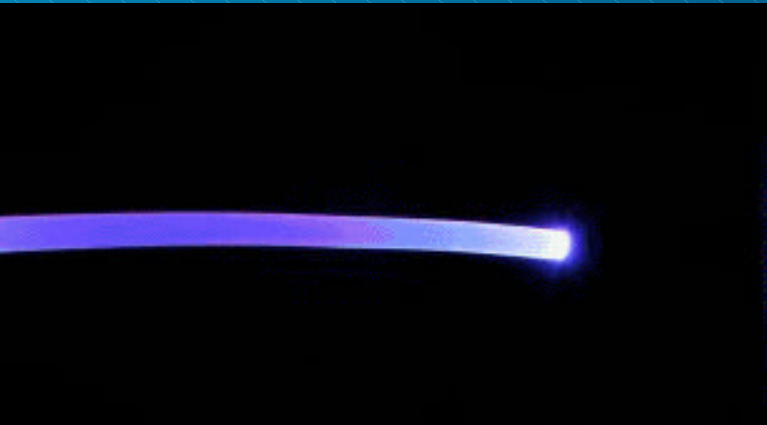

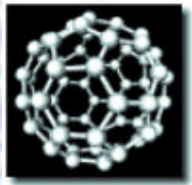

High flux compatible with good Resolution High take-off option on D20

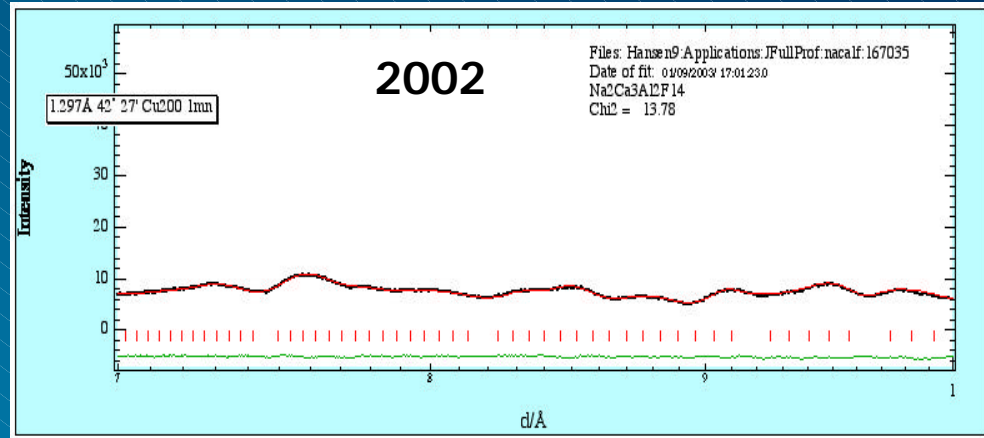
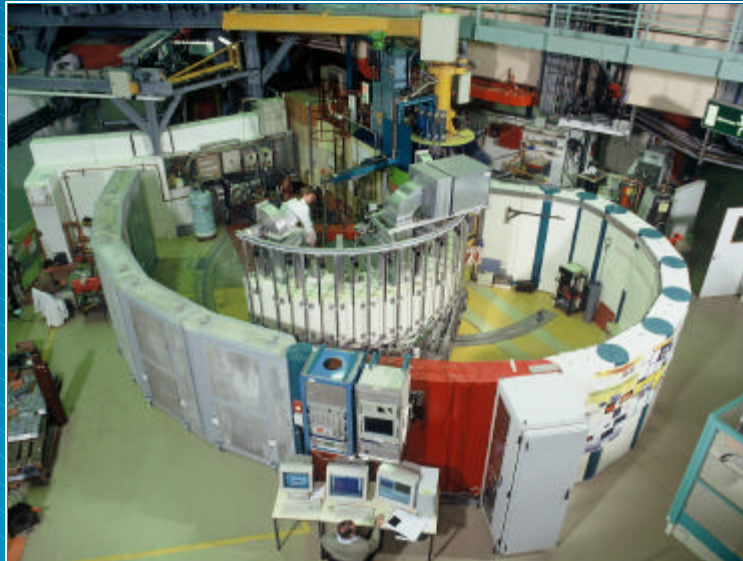

Before and After (data in 2 min.)

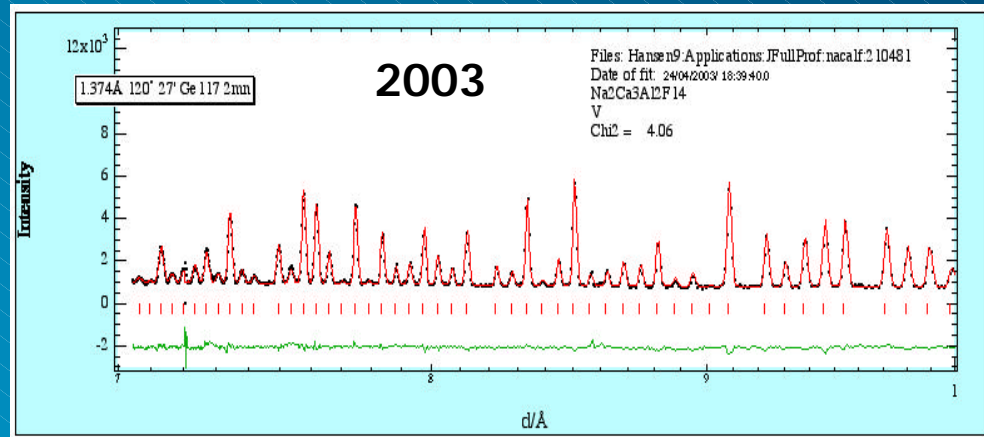
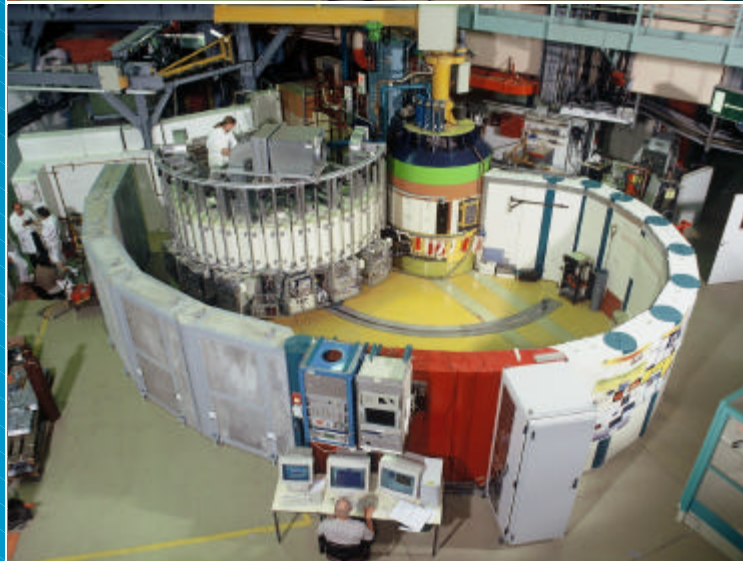

Higher D20 resolution since 2003

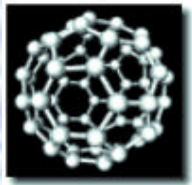

Applications - fast detectors, small samples



Very fast chemical and electrochemical kinetics

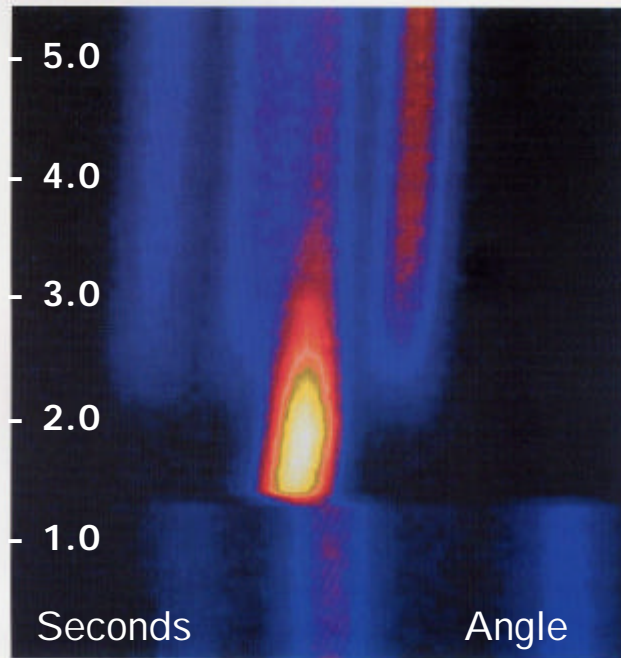

- The explosive SHS reaction was studied in real time with neutrons
- The reaction is exothermic, & heats the sample to 2200°C in <1 sec
- The complete diffraction pattern (left) is collected at 300 ms intervals - **A World Record**

Journal
of the American Ceramic Society
Incorporating Advanced Ceramic Materials and Communications
Volume 85 - Number 10
October 2002

D.Riley, E.Kisi, T.Hansen, A.Hewat (2002)

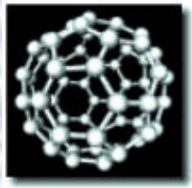

New radial collimator for D20 New high pressure cell

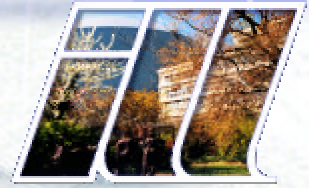

cf radial collimators on ISIS-GEM, PSI-HRPT etc
New Paris-Edinburgh pressure cell

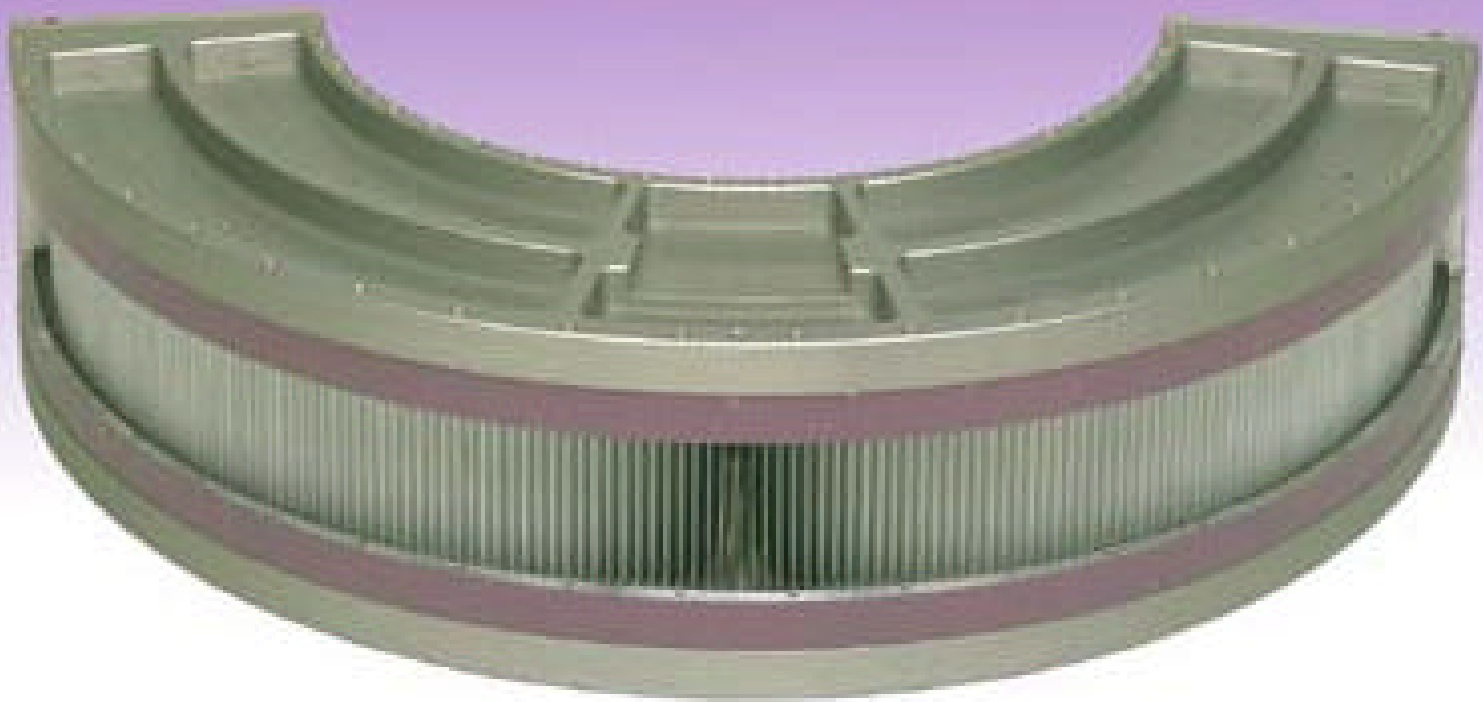

Super-D2B Millennium Project High resolution 2D-detector

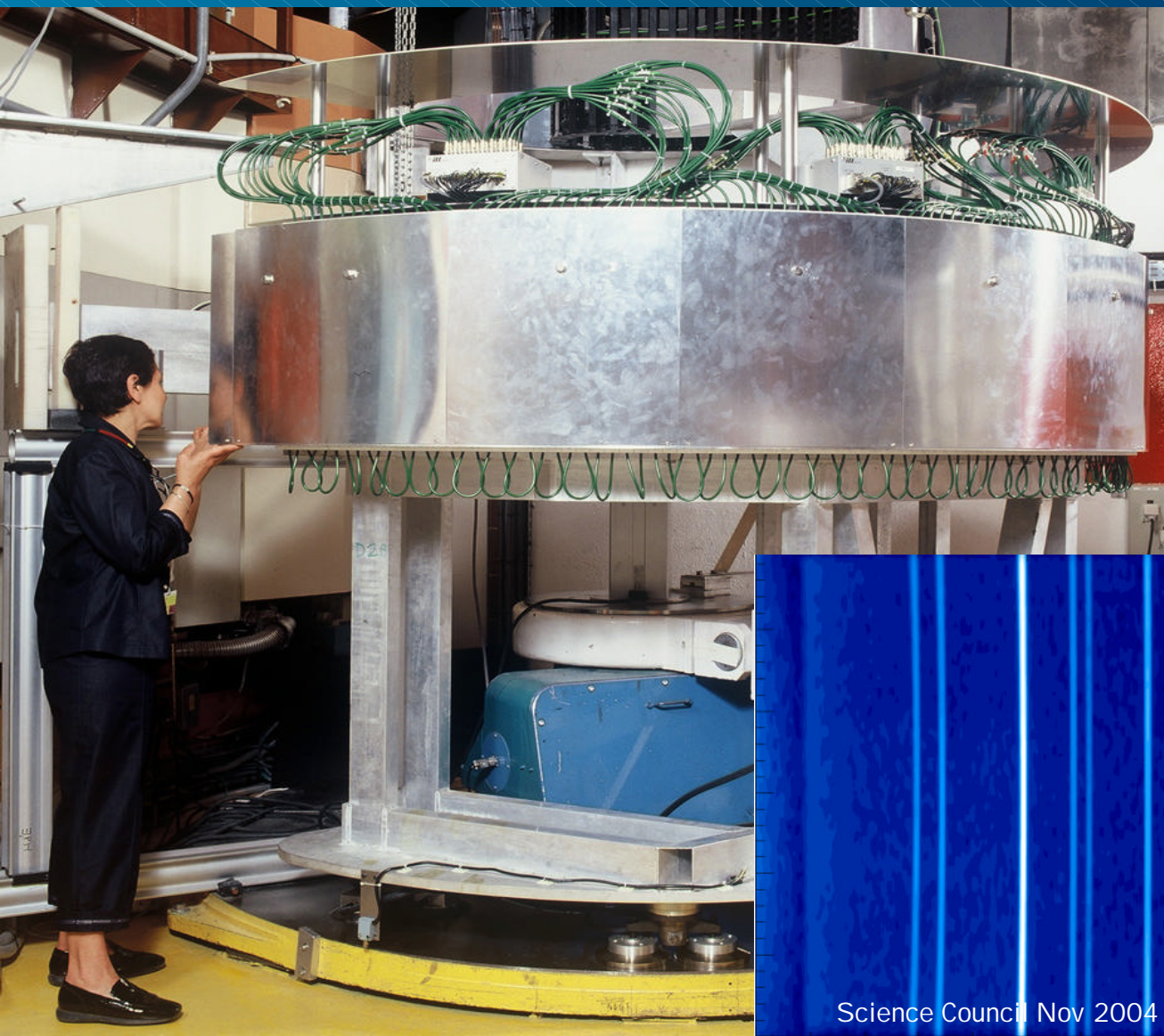

**New D2B-2003
Very High Res.
X6 intensity**

**1st 2D detector
For Neutron PD**

**Integrate over
Diffraction Cones**

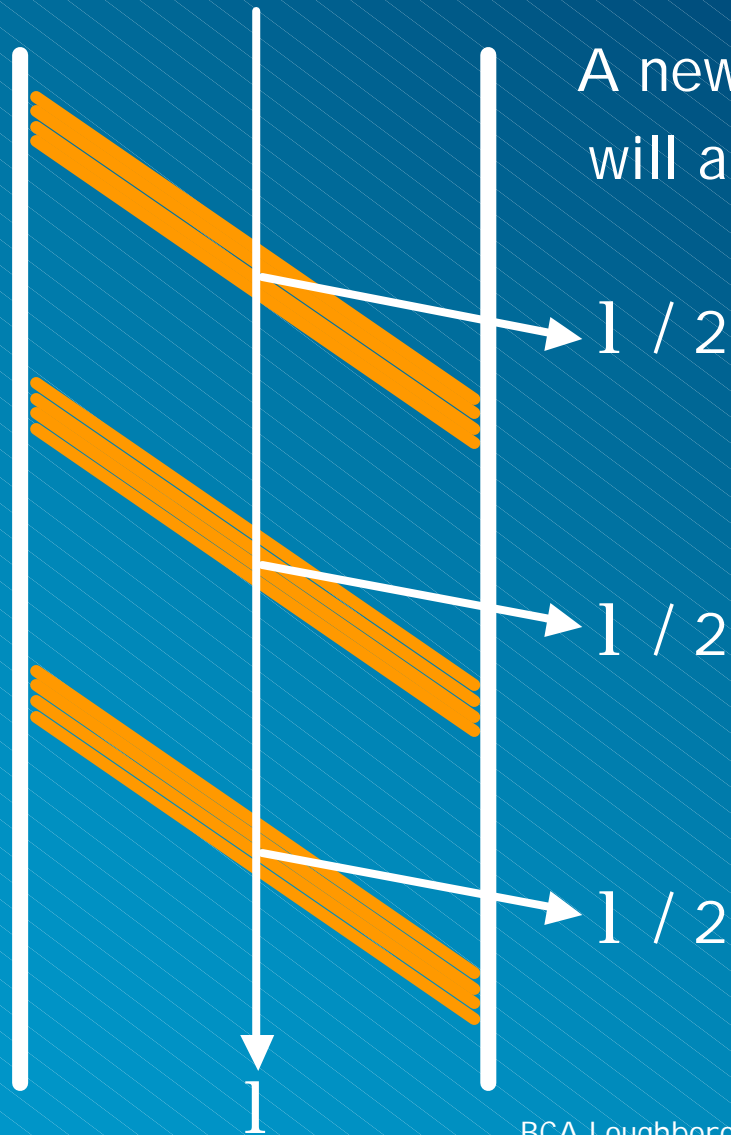
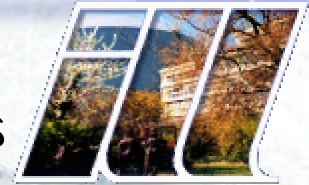

A new type of graphite filter
will allow $\lambda=6.0\text{\AA}$, 3.0\AA , 2.4\AA

D19 Millennium Project

Large 2D detector for biological structures



New D19-2004
The Future for ILL
DRACULA, D9, D16



D19 Millennium Project

Large 2D detector for biological structures



Complete D19 detector, 11 April 2005

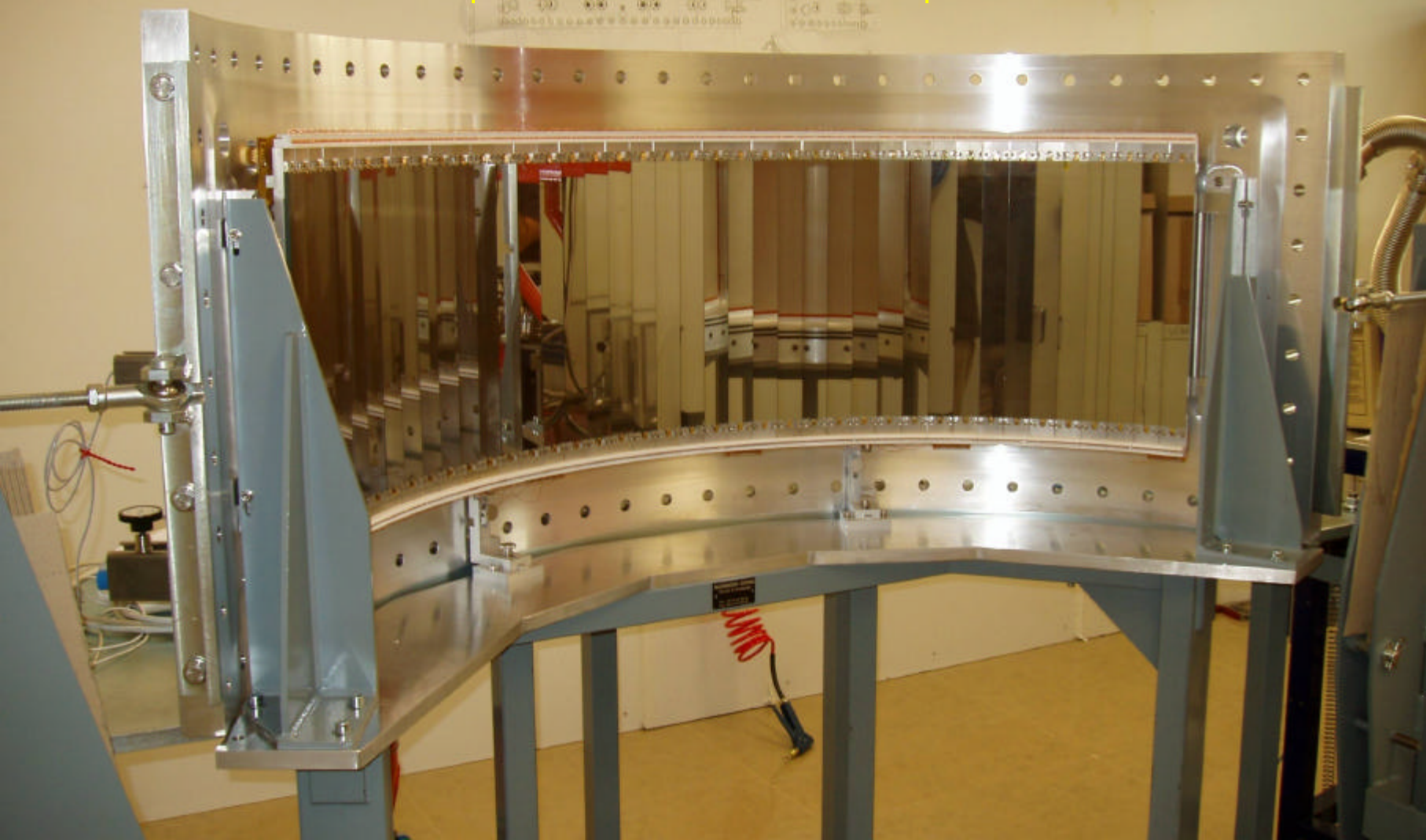

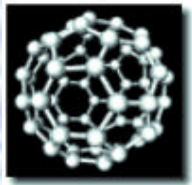

ILL Diffraction Needs a 2nd Thermal Beam

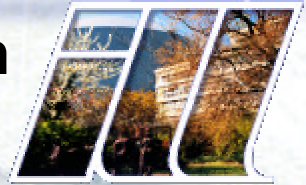

Diffractometer for
Rapid
Acquisition over
Ultra
Large
Areas

DRAC, first presented at the ILL "Instrument Day" 26 Feb 2002

DRAC, highest priority for Instrument Committee 17 Oct 2003

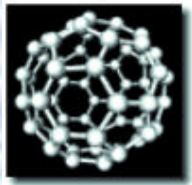

Why is sample flux so high from a reactor?



Large wavelength-band focusing monochromators
Focusing in reciprocal space can give a factor of x10

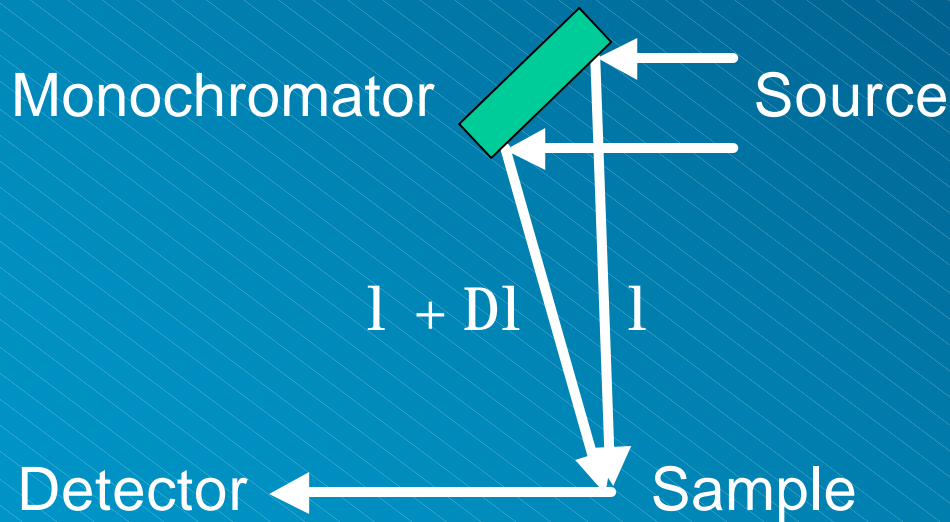

$$\Delta d/d \sim 0.1\% \text{ for } \Delta\lambda/\lambda \sim 1\%$$



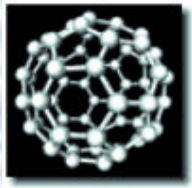

Comparison of TOF & CW Diffractometers



The time-averaged **Flux*Detector** criterium

With big detectors we can compete with the SNS intensity
The time-average sample flux is higher on a CW source.

	D20	GEM	DRACULA	SNS
Flux average on sample	5×10^7	$\sim 2 \times 10^6$	$\sim 10^8$	$\sim 2.5 \times 10^7$
Detector solid angle	0.27 sr	4.0 sr	1.5 sr*	3.0 sr
Efficiency=Flux*Detector	1.7	1	18	9

* Based on new D19 detector: R=760 mm, h=400 mm, 800 linear resistive wires 30°x160°



High Flux Neutron Diffractometers

Alan Hewat, ILL Grenoble

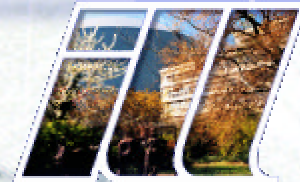

Register now on: <http://www.ill.fr/dif/epsrc/>

Spring 2005
Conference
on EPSRC-ILL
Millennium Projects



May 25-27 at ILL Grenoble France